

# 8A, 6.5V, 2.1MHz Synchronous Step-Down Converter Evaluation Board

## ***General Description***

The RTQ2158 is a high-performance, synchronous step-down converter that can deliver up to 8A output current with an input supply voltage range of 2.85V to 6.5V. This document explains the function and use of the RTQ2158 evaluation board (EVB), and provides information to enable operation, modification of the evaluation board, bill of materials and schematic to meet individual requirements.

## **Table of Contents**

General Description .....	1
Performance Specification Summary .....	2
Power-up Procedure .....	2
Detailed Description of Hardware .....	3
Bill of Materials .....	5
Typical Applications .....	6
Evaluation Board Layout .....	8
More Information .....	10
Important Notice for Richtek Evaluation Board .....	10

## Performance Specification Summary

Summary of the RTQ2158 Evaluation Board performance specification is provided in Table 1. The ambient temperature is 25°C.

Table 1. RTQ2158 Evaluation Board Performance Specification Summary

Specification	Test Conditions	Min	Typ	Max	Unit
Input Voltage Range		2.85	--	6.5	V
Output Current		--	8	--	A
Default Output Voltage		--	1.2	--	V
Operation Frequency		--	460	--	kHz
Output Ripple Voltage	I <sub>OUT</sub> = 8A	--	10	--	mVp-p
Line Regulation	I <sub>OUT</sub> = 8A, V <sub>IN</sub> = 3V to 6.5V	--	±1	--	%
Load Regulation	V <sub>IN</sub> = 5V, I <sub>OUT</sub> = 0A to 8A	--	±1	--	%
Load Transient Response	I <sub>OUT</sub> = 0A to 8A	--	±5	--	%
Maximum Efficiency	V <sub>IN</sub> = 5V, V <sub>OUT</sub> = 1.2V, I <sub>OUT</sub> = 8A	--	77	--	%

## Power-up Procedure

### Suggestion Required Equipment

- RTQ2158GQWT Evaluation Board
- DC power supply capable of 10A
- Electronic load capable of 12A
- Function Generator
- Oscilloscope

### Quick Start Procedure

The Evaluation Board is fully assembled and tested. Follow the steps below to verify board operation. Caution: Do not turn on supplies until all connections are made. Note: When measuring the output voltage ripple, care must be taken to avoid a long ground lead on the oscilloscope probe. Measure the output voltage ripple by touching the probe tip and ground ring directly across the last output capacitor.

### Proper measurement equipment setup and follow the procedure below.

1. Turn off the power and connect the input power supply to the VIN and GND pins.
2. Turn off the power and connect the electronic load between the VOUT and the nearest GND pins.
3. Turn on the power supply at the input, ensuring that the input voltage does not exceed 5V on the Evaluation Board.
4. Use a voltmeter to check for the proper output voltage.
5. Once the proper output voltage is established, adjust the load within the operating ranges and observe the output voltage regulation, ripple voltage, efficiency, and other performance metrics.

## Detailed Description of Hardware

### Headers Description and Placement

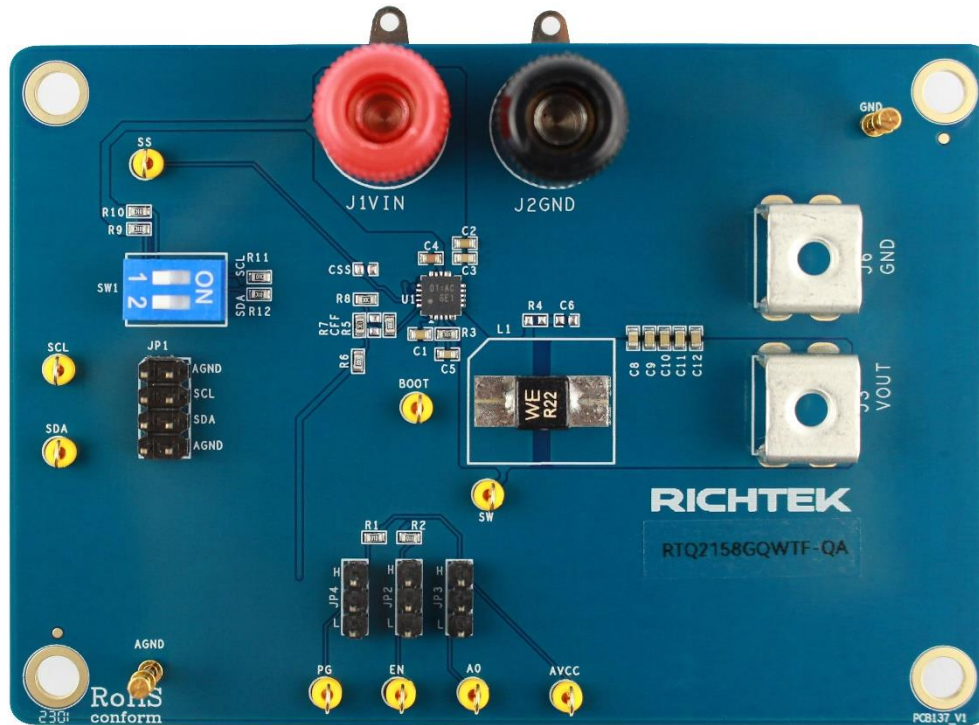

Carefully inspect all the components used in the EVB according to the following Bill of Materials table, and then make sure all the components are undamaged and correctly installed. If there is any missing or damaged component, which may occur during transportation, please contact our distributors or e-mail us at [evb\\_service@richtek.com](mailto:evb_service@richtek.com).

### Enable

To automatically start, pull the EN pin to VIN through JP2. Similarly, the converter can be shut down by shorting the EN pin to GND through JP2.

### Test Points

The EVB is provided with the test points and pin names listed in the table below.

Test point/ Pin Name	Function
<b>EN</b>	Enable control input.
<b>BOOT</b>	Supply for high-side gate driver.
<b>SW</b>	Switch node.
<b>PGND</b>	System GND.

Test point/ Pin Name	Function
<b>VIN</b>	Support 2.85V to 6.5V input voltage.
<b>AVCC</b>	Internal regulator output.
<b>AGND</b>	Signal ground.
<b>PG</b>	Open-drain, power-good indication output.
<b>SS</b>	Soft-start time control pin.
<b>FB</b>	Feedback input.

**Bill of Materials**

Reference	Qty	Part Number	Description	Package	Manufacturer
U1	1	RTQ2158GQWTF-QA	Step-Down DC-DC Converter	WET-WQFN-21L 4x4 (FC)	RICHTEK
C1, C2, C9, C10, C11, C12	6	GRM187R61A226ME15	22 $\mu$ F/10V/X5R	0603	MURATA
C3, C5, C8	3	0603B104K500CT	100nF/50V/X7R	0603	WALSIN
C4	1	GRM188R61E475KE11D	4.7 $\mu$ F/10V/X5R	0603	MURATA
L1	1	WURTH 744316022	0.47 $\mu$ H	5040	WE
R1, R2	2	WR06X1003FTL	100k	0603	WALSIN
R3	1	WR06X20R0FTL	20	0603	WALSIN
R5, R6	2	RAT030000FTP	0	0603	RALEC
R7	1	WR06X1332FTL	13.3k	0603	WALSIN
R8	1	WR06X2002FTL	20k	0603	WALSIN
R9, R10, R11, R12	4	WR06X1002FTL	10k	0603	WALSIN

**Typical Applications**

**EVB Schematic Diagram**

RTQ2158GQWTF demo board:  $V_{IN} = 5V$ ,  $V_{OUT} = 1.2V / 8A$

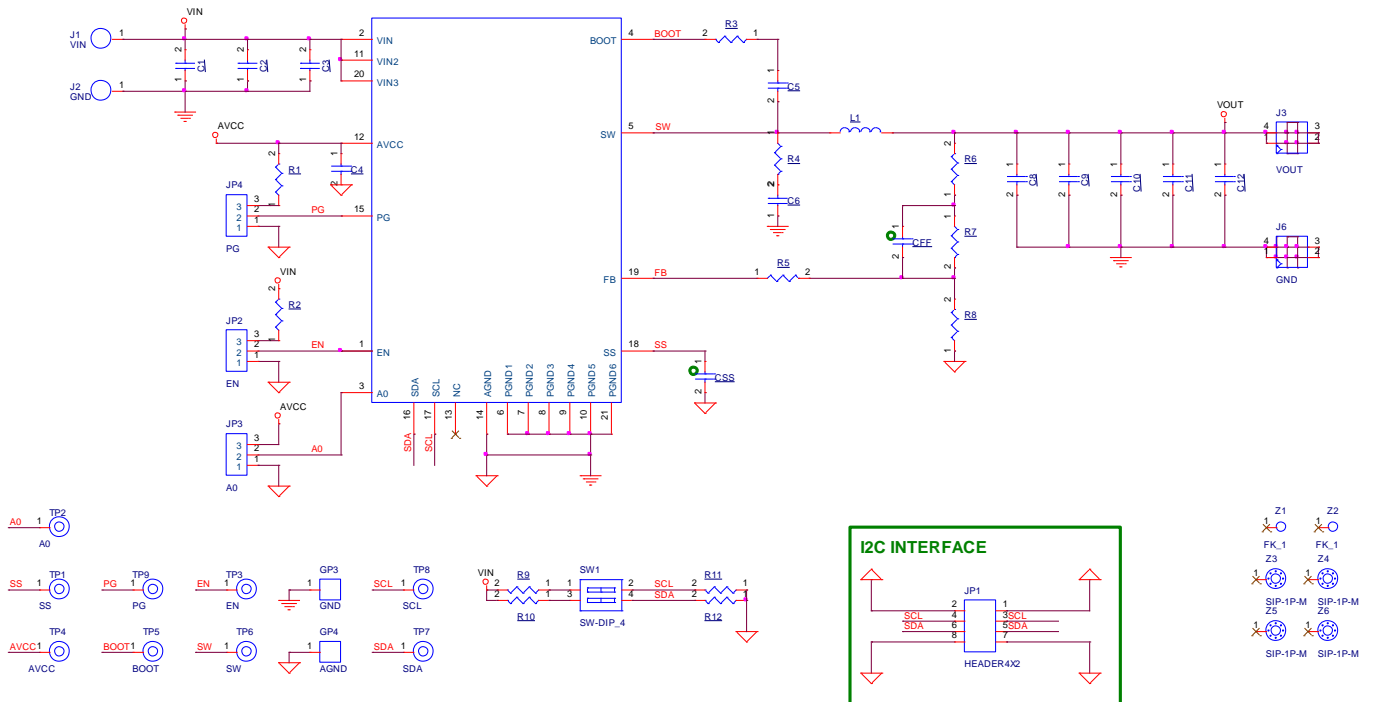

1. The capacitance values of the input and output capacitors will influence the input and output voltage ripple.
2. MLCC capacitors have degrading capacitance at DC bias voltage, and especially smaller size MLCC capacitors will have much lower capacitance.

**Measurement Results**

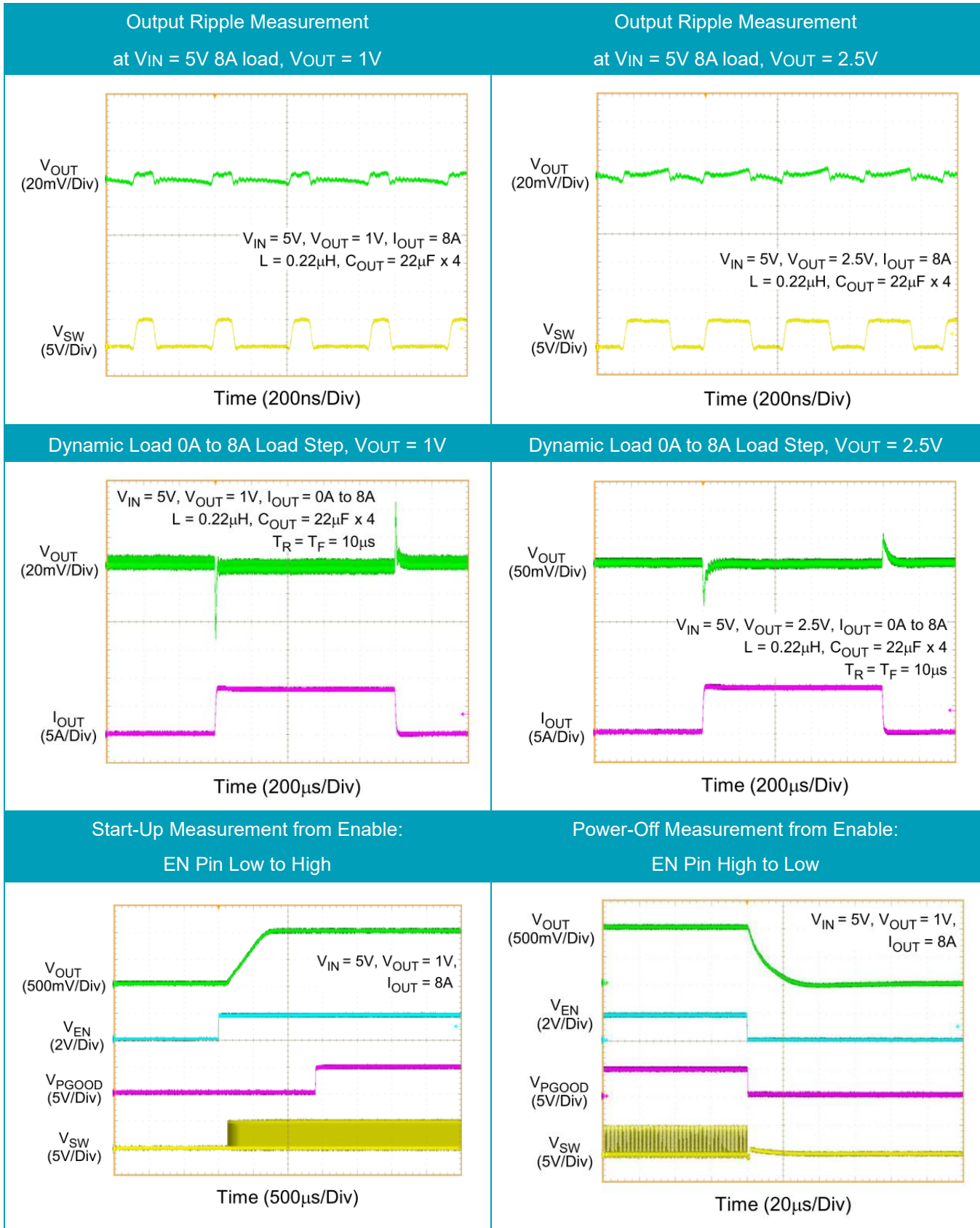

**Evaluation Board Layout**

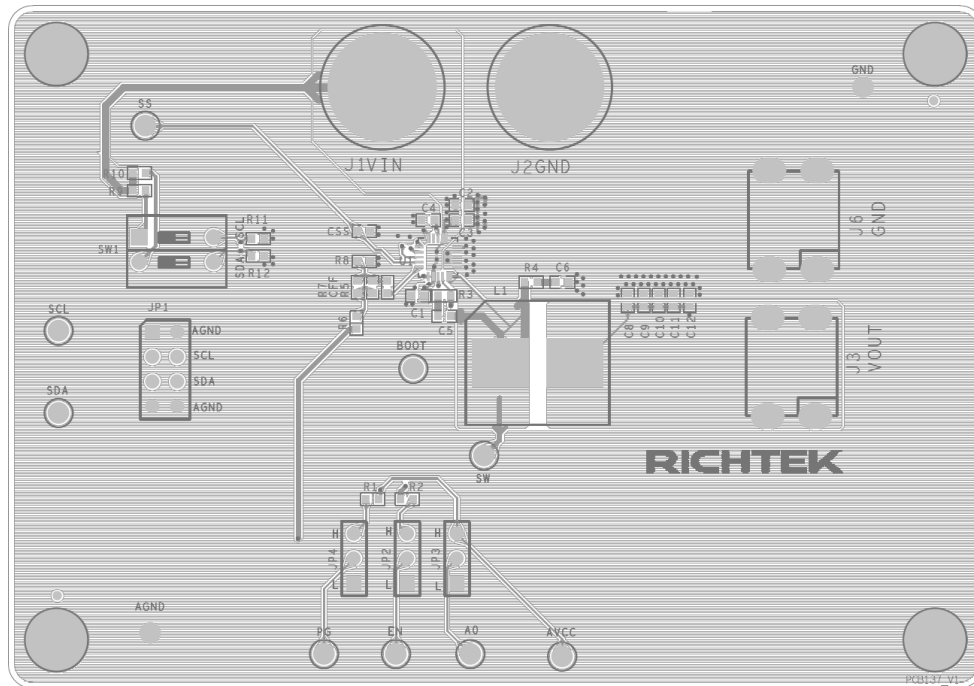

Figure 1. Top View (1<sup>st</sup> layer)

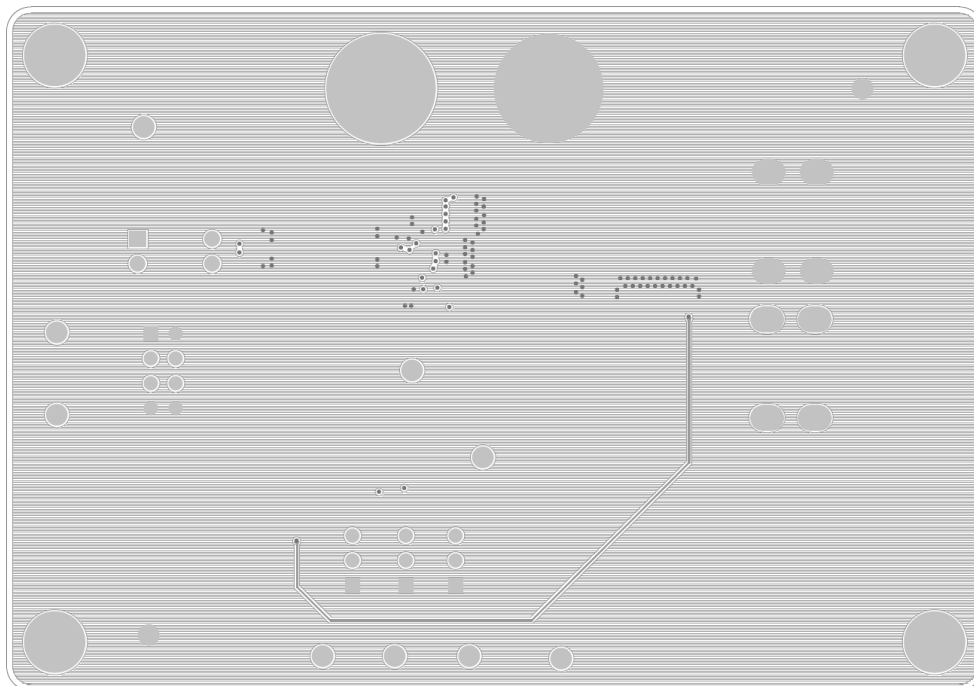

Figure 2. PCB Layout—Inner Side (2<sup>nd</sup> Layer)



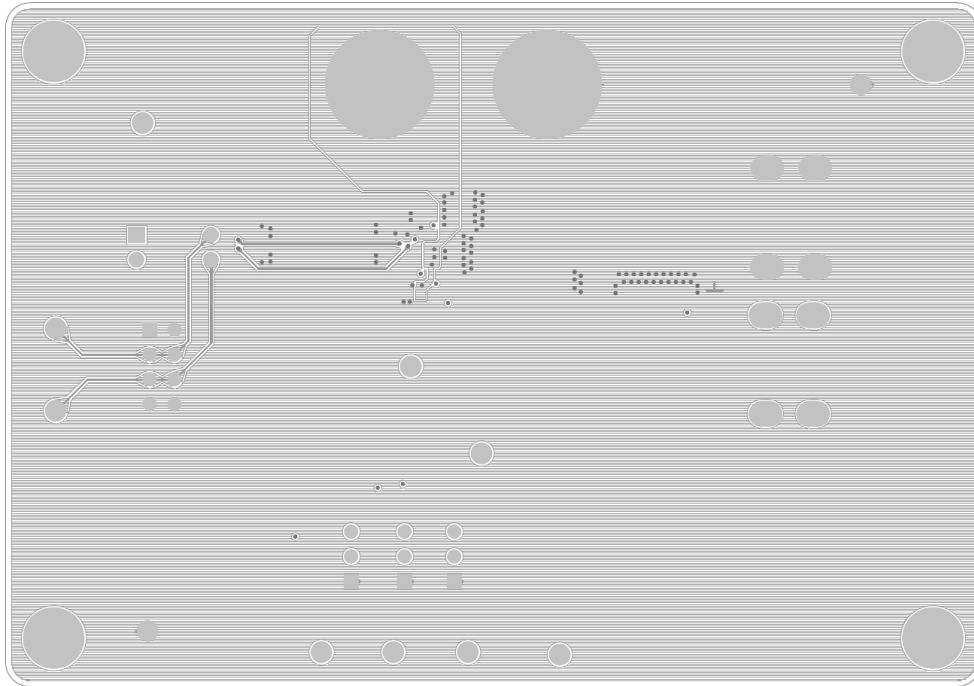

Figure 3. PCB Layout—Inner Side (3<sup>rd</sup> Layer)

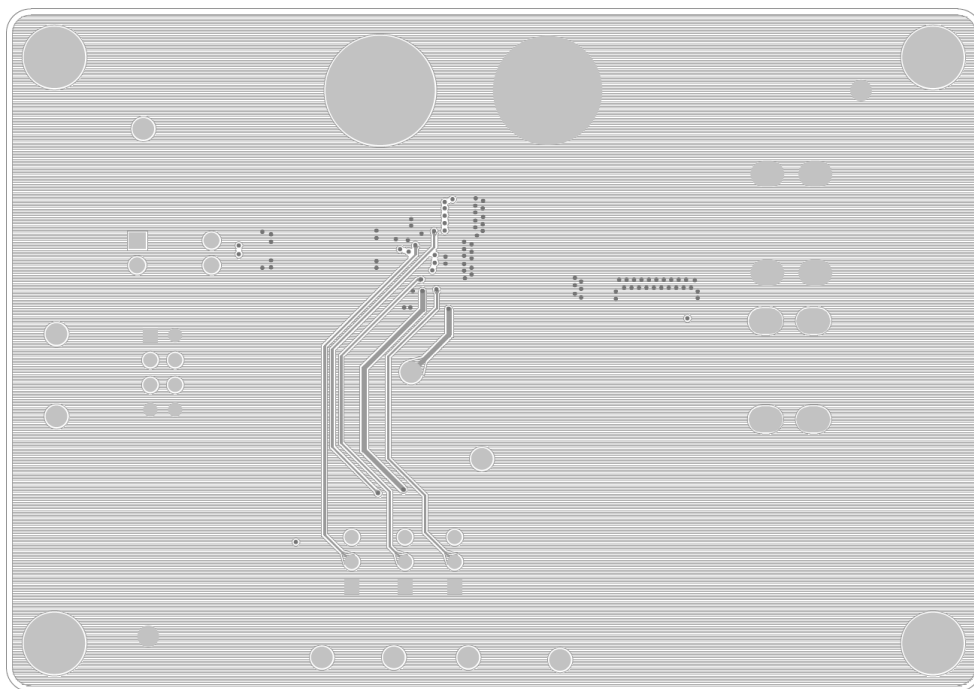

Figure 4. Bottom View (4<sup>th</sup> Layer)

### ***More Information***

For more information, please find the related datasheet or application notes from Richtek website <http://www.richtek.com>.

### ***Important Notice for Richtek Evaluation Board***

THIS DOCUMENT IS FOR REFERENCE ONLY, NOTHING CONTAINED IN THIS DOCUMENT SHALL BE CONSTRUED AS RICHTEK'S WARRANTY, EXPRESS OR IMPLIED, UNDER CONTRACT, TORT OR STATUTORY, WITH RESPECT TO THE PRESENTATION HEREIN. IN NO EVENT SHALL RICHTEK BE LIABLE TO BUYER OR USER FOR ANY AND ALL DAMAGES INCLUDING WITHOUT LIMITATION TO DIRECT, INDIRECT, SPECIAL, PUNITIVE OR CONSEQUENTIAL DAMAGES.